



RENAULT
Passion for life

Renault KADJAR



October 2020

5 YEAR
WARRANTY
100,000 MILES



An athletic appearance

An SUV through and through, the Renault KADJAR proudly sports its adventurous look and powerful design. Evidencing its authentic personality, its chrome-finish grille surrounded by LED lights* really make KADJAR stand out. At the rear, fog lights keep watch: dust, mist, drizzle, nothing will stop you. Featuring new front and rear skid plates, the 19" alloy wheels^ are ready to take up any kind of terrain. Its shark fin antenna† on the roof combines perfect aerodynamics and unique style.

*Available from S Edition

^Available from Iconic

†Shark fin antenna from Iconic

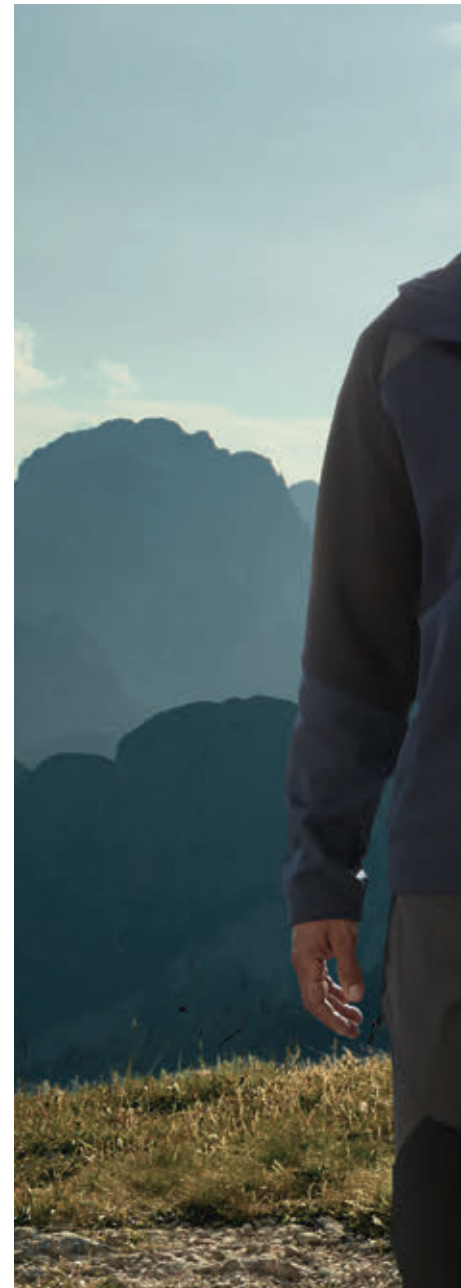







On-board comfort

Explore every detail of your KADJAR's interior comfort. With its contemporary environment, perfect ergonomic design, new upholstery and chrome-finish trim, you'll enjoy every moment you spend inside it. Comfortably installed behind the wheel, you'll be ready to appreciate the most demanding of roads. The restyled dashboard, the back-lit central console and numerous redesigned details will make you want to embrace adventure in a whole new way.







Ready for all discoveries

Renault KADJAR excels on the most improbable terrain. With its raised ground clearance, chrome finish side protection fittings and front and rear skid plates, it will take on challenging terrain just as easily as it does your everyday journeys. KADJAR will offer you comfort regardless of the road ahead.



Adaptive instinct

You'll also find plenty of spaces inside your Renault KADJAR. By simply folding down the rear bench seat*, in the flat position you'll enjoy substantial loading volume that is easy-to-use when the floor of the boot is in the raised position. Mountain bikes, rucksacks, hiking equipment and accessories letting you take on life. And your passengers will be spoiled: the large cup holders in the front, together with the air-conditioning vents and USB ports in the rear* will change the whole travel experience for them. And as the driver, you'll be nicely cradled in your heated adjustable seat** with sliding armrests, ready to enjoy the most demanding of roads. Yes to adventure – but with everything you need to enjoy it to the full!

*Available from Iconic **Available from GT Line





Efficiency without compromise

The engines powering the Renault KADJAR are advanced, reliable and efficient. Fitted with the Stop & Start system with regenerative braking, they include a host of technologies (downsizing, friction reduction, latest-generation injection systems) that elevate them to exemplary levels of performance and consumption, all without sacrificing your driving pleasure.

TCe 140 **Flexibility and control**

Flexible and responsive, this petrol engine delivers power with its turbo function and economy with low fuel consumption.

EDC dual-clutch gearbox **Comfort, moderate** **consumption and technology**

This 7-speed automatic dual-clutch gearbox offers smooth, jerk-free gear changes. Dynamic and responsive, the EDC responds instantly to the slightest driver input. In terms of economy, its fuel consumption is similar to that of a mechanical gearbox.





The world at your fingertips

Integrated into the new central console, the R-LINK2[^] multimedia system's 7" touchscreen is ergonomically-designed and intuitive. When connected, R-LINK 2 gives you access to a wide range of services such as TomTom[™] Traffic* so you get the latest traffic information in real time. With Android Auto^{™**} and Apple CarPlay^{™**}, easily access your smartphone's driving-compatible apps directly from the R-LINK 2 screen. With the MY Renault^{**} application connected to your R-LINK 2, take advantage of smart services wherever you are and at any time (to find where you've parked your Renault KADJAR, for example!). R-LINK 2 optimises the on-board experience and delivers a fluid, simple and customised multimedia experience.

*For a limited period.

[^]Available from Iconic

** Compatibility: An Android phone running Android 5.0 (Lollipop), an iPhone no earlier than iPhone 5 & iOS7.1. Connecting a smartphone to access Android Auto[™] and Apple CarPlay[™] should only be done when the vehicle is safely parked. Drivers should only use the system when it is safe to do so and in compliance with the requirements of The Highway Code. Drivers should be aware of the potential of hands-free technology to distract a driver's attention from the road, preventing them from having full control of the vehicle.

Controlled trajectories

To make sure that you have as much control as possible during each and every one of your adventures, 2 cameras, 12 sensors and a radar keep a constant watch on your movements. The speed alert system with traffic sign recognition* system helps you adapt your driving to road sign data captured by the camera. A visual alert is shown on your dashboard and suggests saving it as the value for the speed limiter.

The Lane Departure Warning[^] will let you know when you have strayed across a continuous broken line without indicating.

*Available on GT Line only

[^]Available from Iconic





Renault KADJAR
Feel comfortable on any adventure

Standard features

ICONIC MY21 - All the essentials of a modern SUV



ZEUS - 19" diamond cut alloy wheels



Synthetic leather and cloth upholstery



Driving Assistance

- ABS with EBD – Electronic brake distribution and emergency brake assist
- Automatic high beam headlights
- Automatic headlights
- Cruise control with speed limiter
- Eco-Mode
- Electronic Parking Brake
- Front fog lights with cornering function
- Hill Start Assist
- Front and rear parking sensors with rear parking camera
- Insurance approved (Category 1) alarm system and immobilizer
- ISOFIX Child seat anchorage points on rear outer seats
- Lane Departure Warning
- R.A.I.D (Renault Anti Intruder Device) auto closure >6mph
- Tyre pressure monitor system
- 3 points rear center seatbelt
- Tyre Inflation Kit
- Tyre Pressure Monitor

Exterior

- 19" Diamond Cut 'Zeus' alloy wheels
- Body side mouldings with chrome inserts
- Electric folding automatic and heated door mirrors
- Extra-tinted rear windows and tailgate
- Longitudinal roof bars
- Shark fin Antenna
- Windows chrome surround
- LED Daytime running lights

Interior

- Passenger height adjustable seat
- Synthetic leather steering wheel
- Back-illuminated central console
- Daylight/nightlight rear-view mirror
- TFT Driver information display
- Sliding front centre armrest
- Windows - Tinted rear and tailgate
- 60:40 split folding seats

Comfort and Convenience

- Driver sunblind with illuminated mirror and ticket holder
- Driver – Height and lumbar adjustable seat
- Door Mirrors - body coloured, auto folding, electrically adjustable and heated
- EasyLife quick folding rear seats
- Hands-free keycard
- Rear passenger air vents
- Multi positional boot floor
- Automatic dual zone climate control
- Driver – Height adjustable seat
- Electric Front and Rear windows
- Exterior temperature indicator
- Halogen headlights
- Heated rear screen
- Socket front – 12v socket
- Multi-functional trip computer
- Steering wheel – Power assisted, height, rake and reach adjustable

Communication and on-board technology*

- R-LINK 2 7" touchscreen with navigation, TomTom™ LIVE , Bluetooth®, DAB radio, USB port and compatible with Android Auto™ & Apple CarPlay™
- Two rear USB sockets
- 4x35W speakers with 3D sound

*For compatible devices, please refer to <https://www.renault.co.uk/services/multimedia/bluetooth-compatibility.html>

Standard features

S EDITION MY21 - Added style and comfort



ZEUS - 19" diamond cut alloy wheels



Black fabric upholstery with blue top-stitching



Additional equipment to ICONIC

Driving Assistance

- Full LED headlights with LED turn indicators
- LED fog lights with cornering function

Exterior

- Chrome finish fog lights surrounds
- Fixed glass panoramic sunroof
- Saturn grey front and rear skid plates
- Side and boot kick plates

Interior

- Dark Blue 3D TEP fabric with synthetic leather upholstery with Blue top-stitching
- Electrochrome rear-view mirror

Standard features

GT LINE MY21 - A premium look with a host of technologies



POSEIDON - 19" diamond cut alloy wheels

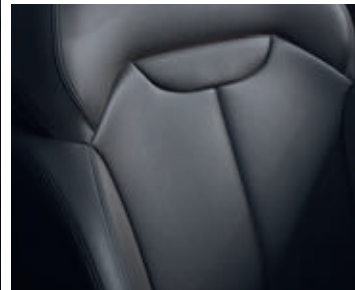

Dark leather upholstery



Additional equipment to S EDITION

Driving Assistance

- Active Emergency Braking System (AEBS)
- Blind Spot Warning
- Over speed and Traffic Sign Recognition
- Flank Protection

Exterior

- 19" Diamond cut 'POSEIDON' alloy wheels
- Front Grille with chrome enrichment
- Adamantium front & rear skid plates

Interior

- Black Leather Upholstery with synthetic leather head rest
- Leather steering wheel

Comfort and Convenience

- Hands-free parking
- Heated front seats and electrically adjustable driver's seat (fore/aft, height and recline)
- Driver and passenger cushion length extender

Communication and on-board technology*

- BOSE® premium sound system: 7 speakers with a digital amplifier + 1 Subwoofer

Colours

Iron Blue (3) (RQH)



Arctic White (3) (QNC)



Flame Red (3) (NNP)



Cosmos Blue (2) (RPR)



Titanium Grey (2) (KPN)



Highland Grey (2) (KQA)



Diamond Black (2) (GNE)



Glacier White (1) (369)



	Glacier White (369)	Diamond Black (GNE)	Titanium Grey (KPN)	Highland Grey (KQA)	Cosmos Blue (RPR)	Flame Red (NNP)	Arctic White (QNC)	Iron Blue (RQH)
Iconic	●	○	○	○	○	○	○	○
S Edition	●	○	○	○	○	○	○	○
GT-Line	●	○	○	○	○	○	○	○

● = Standard (therefore no cost) ○ = Optional

Every effort has been made to ensure that the information, descriptions, and images were correct at the time of publication however images may not always reflect the exact version selected. It should be noted that limitations on screen do not permit the subtle paintwork shades on this page to be shown with absolute accuracy.





Accessories

Experience your KADJAR to the max with our accessory* packs

LIGHTING PACK**

Illuminated Door Sills and Side Styling Bars with Entry light



PET PACK

Partition Grille and All-in-one Boot Liner



ROOF BARS



SIDE STEPS**



ROOF BOX‡



*All accessories available to order individually. ** These accessories require registration of the vehicle before fitment. For more information, consult the KADJAR accessories brochure. For prices, please refer to Renault Car Price Guide. Accessories are fitted post-production, and may have an impact on real world fuel (actual) consumption and CO₂ figures.

Accessories

Experience your KADJAR to the max with our accessories*

PREMIUM MATS



STANDARD BOOT LINER



ALL-IN-ONE BOOT LINER



WIRELESS PHONE CHARGER



SPORT PEDALS



KENWOOD DASHCAM

The on-board camera automatically starts recording as soon as the vehicle ignition is switched on.



INDIVIDUAL ACCESSORIES

STYLE

Sport Pedals

Side Styling Bars

Side Steps**

PROTECTION

Standard Boot Liner

All-in-one Boot Liner

Kenwood Dashcam

TRANSPORT

Roof Bars

Urban Loader Roof Box

Retractable Tow Bar**

ACCESSORY PACKS

Explore Pack** - Retractable Towbar and Euroride Carrier for Two Bikes

Pet Pack - Partition Grille and All-in-one Boot Liner

Lighting Pack** - Illuminated Door Sills and Side Styling Bars with Entry Light

*All accessories available to order individually. ** These accessories require registration of the vehicle before fitment.

For more information, consult the KADJAR accessories brochure. For prices, please refer to Renault Car Price.

Accessories are fitted post-production, and may have an impact on real world fuel (actual) consumption and CO₂ figures.

Equipment and options

	Iconic	S Edition	GT Line
SAFETY AND DRIVING ASSISTANCE			
Driver and passenger adaptive front airbags (passenger airbag can be disabled)	•	•	•
ABS with Emergency Emergency Brake Assist	•	•	•
Active Emergency Braking System (AEBS)	-	-	•
Airbags - Curtain front and rear	•	•	•
Airbags - Driver's two stage adaptive airbag	•	•	•
Airbags - Deactivation of front passenger (for use with child seats)	•	•	•
Airbags - Front lateral	•	•	•
Airbag - front passenger's two stage adaptive airbag	•	•	•
Intergrated C Shape Indictaors with side repeaters	•	•	•
Automatic headlights and wipers	•	•	•
Automatic High and Low Beam	•	•	•
Cruise control with speed limiter	•	•	•
ESP (Electronic Stability Programme) with ASR (Anti-Skid Regulation) and UCL (Understeer Logic Control)	•	•	•
Lane Departure Warning	•	•	•
Speed alert with traffic sign recognition	-	-	•
Blind Spot Warning	-	-	•
LED Front fog lights with corner function	-	-	•
Front fog lights with corner function	•	•	-
Rear LED fog lights	•	•	•
Halogen headlights	•	-	-
Full LED headlights	-	•	•
Power Assisted Steering	•	•	•
Rear Parking Sensors	-	-	-
Front and Rear Parking Sensors	•	•	•
Rear Parking Camera (incl. Front and Rear Sensors)	•	•	•
Height adjustable drivers seat belt	•	•	•
3 points rear center seatbelt	•	•	•
Protective rear brake disc	•	•	•
Seats - height adjustable front seatbelts with double pretentioners	•	•	•
ISOFIX Child seat anchorage points on rear outer seats	•	•	•
Side impact protection bars	•	•	•
Tyre Inflation Kit	•	•	•
Tyre Pressure Monitor	•	•	•
Flank protection	-	-	•
R.A.I.D (Renault Anti Intruder Device) auto closure >6mph	•	•	•
Deadlocking and immobilisher	•	•	•
Insurance approved (Category 1) alarm system and immobilisher	•	•	•
Eco-Mode	•	•	•
LED DRL - Daytime running lights	•	•	•
Hill Start Assist	•	•	•
Gear Change Indicator	•	•	•
Electrical Parking Brake	•	•	•
EXTERIOR DESIGN			
17" alloy wheels - ATHENA	-	-	-
19" diamond cut alloy wheels - ZEUS	•	•	-
19" diamond cut alloy wheels - POSEIDON	-	-	•
Puddle Lamp	-	-	•
Longitudinal roof bars	•	•	•
Fixed panoramic sunroof	-	•	•
Electric door mirrors manual folding - heated	-	-	-
Door Mirrors - Electrically adjustable, heated and folding	•	•	•
Door handles body coloured	•	•	•
Door mirrors - body coloured shell	•	•	•
Body side moulding	-	-	-
Body sided mouldings with chrome inserts	•	•	•
Satin grey front and rear skid plates	-	-	-
Adamantium grey front and rear skid plates	-	-	•
Front fog lights chrome surround	-	•	•
Chrome inserts on front grille	-	-	•
Windows chrome surround	•	•	•
Side and boot kick plates	-	-	•
INTERIOR DESIGN			
WINDOWS			
Heated Rear screen	•	•	•
Electric Front windows	•	•	•
Electric Rear Windows	•	•	•
Tinted Rear windows and tailgate	-	-	-
Extra Tinted Rear windows and tailgate	•	•	•

	Iconic	S Edition	GT Line
SEATING			
Cloth upholstery - Dark Carbon fabric	-	-	-
Synthetic Leather and Cloth upholstery	●	-	-
Dark Blue 3D TEP fabric with synthetic leather upholstery with Blue top-stitching	-	●	-
Carbon Black Leather upholstery with synthetic leather head rest	-	-	●
Driver - Height adjustable seat	●	●	●
Driver - Height adjustable seat with lumbar support	●	●	●
Passenger - Height adjustable	●	●	●
Driver and passenger cushion length extender	-	-	●
Fully adjustable front headrests	●	●	●
Height adjustable front seat belts	●	●	●
Heated front seats and electrically adjustable driver's seat (fore/aft, height and recline)	-	-	●
3-point inertia reel seatbelts	●	●	●
3-seat rear bench	●	●	●
60:40 split folding seats	●	●	●
3 height adjustable rear head restraints	●	●	●
STORAGE			
Sliding front centre armrest	●	●	●
Central rear armrest with cup holders	●	●	●
Multi position boot floor	●	●	●
EasyLife quick folding rear seats	●	●	●
DASHBOARD			
Multi functional trip computer	●	●	●
Rev-counter	●	●	●
Display - Digital speedometer (TFT Screen)	●	●	●
Adjustable dashbaord illumination	●	●	●
Low fuel level warning light	●	●	●
Oil level guage	●	●	●
Exterior Temperature gauge	●	●	●
Rear seat belt undone audible alert	●	●	●
Driver and passenger seat belt undone - warning audible alert	●	●	●
Door/boot open - Warning light	●	●	●
Daylight/nightlight rear-view mirror	●	-	-
Auto-dimming rear-view mirror	-	●	●
OPENINGS			
Keycard - hands-free with walk away lock function	●	●	●
3 button retractable key	-	-	-
HEATING AND VENTILATION			
Air recirculation facility	●	●	●
Pollen filter	●	●	●
Automatic dual zone climate control	●	●	●
Rear passenger airvents	●	●	●
INTERIOR LIGHTING			
Interior Courtesy light controlled by all 4 doors	●	●	●
Driver and passenger reading lights	●	●	●
Rear courtesy lights	●	●	●
Illuminated luggage compartment (on opening of boot)	●	●	●
Back-illuminated central console	●	●	●
COMFORT & MULTIMEDIA			
COMFORT			
Two rear USB sockets	●	●	●
Faux leather steering wheel	●	●	-
Leather steering wheel	-	-	●
Floor Mats Front and Rear	●	●	●
Hands-free Parking	-	-	●
Steering wheel - Rake and reach adjustable	●	●	●
Sun visor with mirror without light	-	-	-
Sun visor with mirror with light	●	●	●
MULTIMEDIA			
Fingertip audio system remote control	●	●	●
7" touchscreen with Bluetooth®, DAB radio, USB port and compatible with Android Auto™ & Apple CarPlay™	-	-	-
Smartphone intergration compatible with Apple CarPlay™ and Android Auto™ [^]	●	●	●
4 x 35W speakers with 3D sound	●	●	-
BOSE® premium sound system: 7 speakers with a digital amplifier + 1 Subwoofer	-	-	●
R-LINK 2 7" touchscreen with navigation, TomTom™ LIVE , Bluetooth®, DAB radio, USB port and compatible with Android Auto™ & Apple CarPlay™	●	●	●

● = Standard; ○ = Optional; - = Not available. [^]Compatibility: An Android phone running Android 5.0 (Lollipop), an iPhone no earlier than iPhone 5 & iOS7.1. Connecting a smartphone to access Android Auto™ and Apple CarPlay™ should only be done when the vehicle is safely parked. Drivers should only use the system when it is safe to do so and in compliance with the requirements of The Highway Code. Drivers should be aware of the potential of hands-free technology to distract a driver's attention from the road, preventing them from having full control of the vehicle.

Key information

For prices, please refer to the Renault Car Price Guide available at your local dealer and on www.renault.co.uk

VERSIONS	WLTP CO ₂ (g/km)*	Combined fuel consumption (mpg)*	HP	Benefit in kind†	Insurance group
Iconic TCe 140 MY21	146	44.1	140	32%	19E
Iconic TCe 140 Auto EDC MY21	144	44.1	140	31%	19E
S Edition TCe 140 MY21	147	43.5	140	32%	19E
S Edition TCe 140 Auto EDC MY21	145	44.1	140	32%	19E
GT Line TCe 140 MY21	147	43.5	140	32%	20E
GT Line TCe 140 Auto EDC MY21	146	44.1	140	32%	20E

*WLTP figures shown are for comparability purposes. Actual real world driving results may vary depending on factors such as weather conditions, driving styles, vehicle load or any accessories fitted after registration. Please visit renault.co.uk/configure for WLTP figures for any selected options. †Benefit in kind figures from 6th April 2020, Renault UK Limited does not offer tax advice and recommends that all Company Car Drivers consult their own accountant with regards to their particular tax position. Depending on options fitted WLTP CO₂ figures may differ, please consult with local dealer or refer to www.renault.co.uk for more information.

OPTIONS	Iconic	S Edition	GT Line
Metallic paint	○	○	○
Renault i.d metallic paint - Arctic White, Flame Red & Iron Blue	○	○	○
Space-saver spare wheel	○	○	○

●= Standard (therefore no cost); ○= Optional;

EASYLIFE SERVICE PLAN

3 Years / 30,000 miles

4 Years / 40,000 miles

One off* and monthly** payment options available

*The EasyLife Service Plan offer is available for all retail vehicles and valid at participating dealers only or Renault.co.uk and can be purchased up to 12 months after registration or before the first service (whichever is sooner). Vehicles must be ordered between 1 October 2020 and 31 December 2020 and registered by 31 March 2021. **The EasyLife Service Plan is available for eligible retail vehicles on a 36 or 48 monthly payment option and are only available at point of signing a finance agreement provided by Renault Finance. Rivers Office Park, Denham Way, Rickmansworth, WD3 9YS. Guarantees and indemnities may be required. You must be a UK resident (excluding the Channel Islands) and over the 18 to apply for finance. Terms & Conditions apply.

The Renault Service plan covers the manufacturer's minimum maintenance programme requirements for the term of the Service Plan purchased (refer to the Warranty and Service sheet in the Handover Document wallet for details). The plan ends when you reach the age or mileage limit (whichever comes first). Services must be carried out in line with the manufacturer's minimum maintenance programme requirements and servicing intervals within +/-1 month or 1,000 miles of the service interval and can only be carried out at a Renault Approved outlet. Service plans do not cover wear and tear items such as (but not limited to) tyres, wiper blades or brakes. For Service plan full Terms & Conditions visit www.renault.co.uk/owners. Cannot be part exchanged, refunded or transferred. All prices quoted are MRRP.

Dimension diagrams

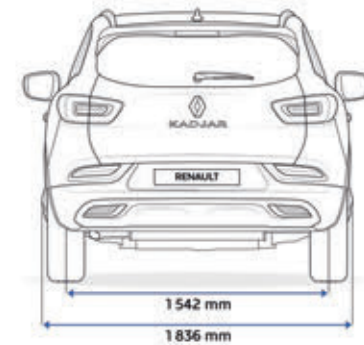
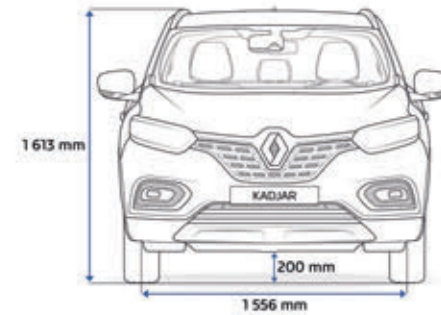
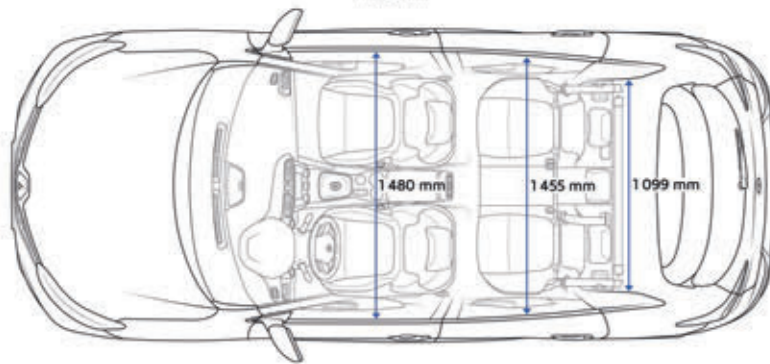
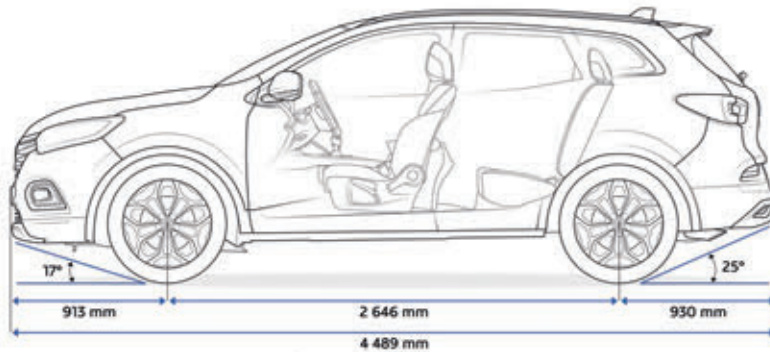

BOOT VOLUME

With inflation kit (VDA volume, dm ³)	472
With inflation kit (volume in litres)	527
Max. loading volume seats folded down (VDA volume, dm ³)	1,478

DIMENSIONED DRAWING (mm)

A	Wheelbase	2,646
B	Overall length	4,489
C	Front overhang	913
D	Rear overhang	930
E	Front track	1,556
F	Rear track	1,542
G	Overall width with/without door mirrors	2,084 / 1,836
H	Unladen height/with longitudinal roof bars	1,607 / 1,613
H1	Height with tailgate open (unladen)	2,076
J	Unladen boot sill height	761

K	Ground clearance	200
L	Knee room in 2 nd row	220
M	Front elbow width	1,480
M1	Rear elbow width	1,455
P	Headroom at 14° in 1 st row (front seats)	905
P1	Headroom at 14° in 2 nd row (rear seats)	910
Y	Interior width between wheel arches	1,099
Z	Max. loading length bench seat folded up/down	864/1,620
R/R1	Angles of front/rear bumpers in degrees	18/28

Technical Specification

	TCe 140	TCe 140 Auto EDC
ENGINE		
Engine type	direct injection-turbo	direct injection-turbo
Emissions conformance	Euro 6D Full	Euro 6D Full
With Particulate Filter (FAP)	GPF (Gasoline particulate filter)	GPF (Gasoline particulate filter)
Induction Capacity (cc)	1333	1333
Bore x Stroke	72.2 x 81.4	72.2 x 81.4
Maximum power - kw ISO	103 kW	103 kW
Maximum Power - hp DIN	140	140
Maximum power - rpm	4500-6000	4500-6000
Maximum Torque - Nm ISO	260	240
Maximum Torque (rpm)	1750-3750	1600-3750
Fuel Type	Petrol	Petrol
Injection type	Direct Injection	Direct Injection
No. of Cylinders	4	4
No. of Valves	16	16
PERFORMANCE		
0- 62 mph - secs (0-100 km/h)	9.8	9.5
Maximum Speed mph (km/h)	124 (200)	124 (200)
Standing km (seconds)	31.1	31.6
FUEL CONSUMPTION* AND EMISSIONS		
WLTP CO ₂ (g/km)	146 - 148	144 - 146
Combined - mpg	44.1 - 43.5	44.1
Combined - l/100 km	6.4 - 6.5	6.4
GEARBOX		
Number of forward gears	6	7
Manual / Automatic	Manual	Automatic (dual clutch)
BRAKING SYSTEM		
Type of braking system	Discs	Discs
ABS	Standard	Standard
EBD	Standard	Standard
Front Ø (mm) / width (mm)	296 / 26	296 / 26
Rear Ø (mm) / width (mm)	290 / 13	290 / 13
SUSPENSION		
Front	Pseudo Mac Pherson with lower triangle	
Rear	Torsion Beam	
STEERING		
Power assisted	Electric with variable assistance	
Turning circle between kerbs (m)	10.72m	10.72m
WHEELS / TYRES		
Standard Wheel Size in inches	19	19
FUEL TANK CAPACITY		
Fuel tank capacity - Litres (Gallons)	55 (12.1)	55 (12.1)
WEIGHT		
Kerb Weight	1333	1362
Gross Vehicle Weight	1894	1920
Maximum Gross Train Weight	3394	3420
Payload	465 / 574	457 / 565
TOWING CAPACITY		
Max (Driver only) Towing weight = braked	1500	1500
Max (Driver only) Towing weight = unbraked	695	715
Maximum load weight on roof	75	75
SERVICING INTERVALS		
Service intervals	18,000 miles or 1 year	

*WLTP figures shown are for comparability purposes. Actual real world driving results may vary depending on factors such as weather conditions, driving styles, vehicle load or any accessories fitted after registration. Please visit renault.co.uk/configure for WLTP figures for any selected options. †Renault UK Limited does not offer tax advice and recommends that all Company Car Drivers consult their own accountant with regards to their particular tax position. Depending on options fitted WLTP CO₂ figures may differ, please consult with local dealer or refer to www.renault.co.uk for more information.

Renault Services

5 Year Warranty

Your Renault car is covered by a warranty package for up to 5 years from date of first registration with unlimited mileage during the first 24 months, then limited to a total of 100,000 miles or 5 years, whichever comes first. Your Renault Dealer is able to repair or replace without charge, parts that are found to have a material or assembly defect that is recognised by Renault. The paintwork warranty runs for 3 years and the anti-corrosion warranty for 12 years^o.

3 Year Roadside Assistance

Should you need it, we'll provide emergency roadside repairs or tow you to the nearest Renault Dealer. This service is available 24 hours a day and is provided for 36 months from the date of first registration (unlimited mileage for first 24 months, then limited to a total of 60,000 miles or 3 years, whichever comes first). Assistance is provided within the UK & Northern Ireland only at roadside, home and includes national recovery and onward travel. Renault Assistance applies to mechanical or electrical defects which are covered by warranty.

For Renault Assistance Terms and Conditions please visit www.renault.co.uk/assistance

EasyLife Service Plan

Renault's EasyLife Service Plan is the ultimate package to provide care free servicing for the first 3 years or 30,000 miles (whichever is sooner). It really is the hassle free way to take care of our Renault and benefits from;

- Inflation Proof Servicing - You know exactly what you'll pay and there are no hidden costs
- Peace of Mind - No matter where life takes you, we'll be there in over 5000 workshops across Europe
- Renault Expertise & Quality - Our highly trained technicians know your Renault inside out

The EasyLife Service Plan contains Renault services in-line with the manufacturer's service schedule, plus comes with a complimentary vehicle health check to ensure your Renault is in the best condition possible.

EasyLife servicing and warranty enhancements also available. Refer to the Price Guide for more details.

One off* and monthly** payment options available.

Finance options***

There are a wide variety of ways in which the purchase of a new vehicle can be financed. Renault Finance offers all of them, so whether you're a fleet buyer or private buyer, Renault Finance is ideally placed to tell you which plan or combination of plans best suits your needs and circumstances.

Renault car insurance¹

A car as well designed as your Renault deserves an insurance policy to match. Renault Insurance has been specifically created to provide superb protection for you and your car. Unlike most other UK insurers, in the event of an accident, Renault Insurance will have your Renault repaired at a Renault Approved Bodyshop using only Renault approved parts and approved repair methods. This maintains your Renault's safety rating, protects its resale value and preserves its Renault warranty^o. Renault Insurance also offers a courtesy car for the duration of a repair at a Renault Approved Bodyshop.

Renault car insurance: **0330 102 7794[†]**
www.renaultcarinsurance.co.uk

Lines are open Mon - Thurs 8.30am - 7pm, Fri 9am - 6pm, Sat 9am - 5pm

Renault iCare

Is an innovative Service, Maintenance & Repair product that supplies Business customers with a fully supported, managed hassle free service and maintenance package.

Renault iCare is a "Pay-As-You-Go" product that insures your vehicle is maintained by Renault technical experts when work is required.

iCare provides the following benefits:

- Full Service, Maintenance & Repair cover in the Renault Dealer Network
 - Tyres can be included within the contract at an additional fixed cost
 - Ancillary equipment can also be included (at an additional fixed monthly cost)
 - Excludes: Damage/Neglect/Abuse/Glass & Bulbs

- A fixed, pre agreed pence per mile rate
- No excess mileage charges at the end of the contract
- No pooled mileage administration
- Minimalise downtime

For more information and to obtain a quote based on your requirements, please speak to your local Renault Business dealer or visit www.renault.co.uk/icare

Customer Relations

Renault knows the value of communicating with its customers and we have established effective ways to keep in touch with you. If after speaking to your local Renault dealership you are not completely satisfied, please contact the Renault UK Customer Relations Department on 0344 3350000[†] (Mon-Fri 9.00am to 5.30pm, except Weds 10.00am to 5.30pm. Closed on Bank Holidays). You can also visit our website www.renault.co.uk or write to us at: Renault UK Ltd, The Rivers Office Park, Denham Way, Maple Cross, Rickmansworth, Hertfordshire, WD3 9YS.



^o 5-year warranty valid on new cars (except Traffic passenger) when registered from 18th December 2019, any new cars registered before this date will receive a 3 year warranty. Exclusions and limitations apply. For Warranty Terms and Conditions please visit www.renault.co.uk/warranty.
^{*}The EasyLife Service Plan offer is available for all retail vehicles and valid at participating dealers only or Renault.co.uk and can be purchased up to 12 months after registration or before the first service (whichever is sooner). Vehicles must be ordered between 1 October 2020 and 31 December 2020 and registered by 31 March 2021. ^{**}The EasyLife Service Plan is available for eligible retail vehicles on a 36 or 48 monthly payment option and are only available at point of signing a finance agreement provided by Renault Finance. Rivers Office Park, Denham Way, Rickmansworth, WD3 9YS. Guarantees and indemnities may be required. You must be a UK resident (excluding the Channel Islands) and over the 18 to apply for finance. Terms & Conditions apply. ^{***}Finance provided by Renault Finance, P.O. Box 149, Watford, WD17 1FJ. Guarantees and indemnities may be required. You must be at least 18 and a UK resident (excludes Isle of Man and Channel Islands) to apply. Subject to status, terms and conditions apply. [†]Calls to 0330 numbers are free if used as part of your inclusive mobile minutes and are charged at local rates from landlines. ^{††}If your insurer uses non-approved parts which subsequently fail, they may not be covered under your manufacturer's warranty. ¹Renault Insurance is arranged and administered by Verex Insurance Services Ltd, which is registered in England and Wales No. 05686831 at Batchworth House, Church Street, Rickmansworth, Herts, WD3 1JE and authorised and regulated by the Financial Conduct Authority, No. 487185. Verex Insurance Services Ltd arranges policies from a panel of insurers, details are available on request.

Extend the Renault KADJAR experience
at www.renault.co.uk



Although every effort has been made to ensure that the information contained within this brochure is as accurate and up to date as possible, Renault U.K. reserves the right to modify its models without notice, including their characteristics, specifications, equipment and accessories. Brochures inevitably become out of date or inaccurate in some respects, in that such characteristics, specifications, equipment, or accessories may be changed after the publication date given below and can differ from the descriptions given or the photos displayed. It is therefore necessary to check with your Renault Dealer before purchasing any product that the characteristics, specifications, equipment or accessories of the vehicle on order are as advertised.

Renault recommends 

 Prodigious

Photo credits: U. Heckmann, P. Giardino, Corbis, Getty Images, E. Haveric, Y. Brossard, A. Bernier, © Renault Marketing 3D-Commerce – 7701 380 819 – October 2020